

# MapStar® TruAngle® II



## User's Manual

1st Edition



1.303.649.1000



ServiceCenter@LaserTech.com



6912 S. Quentin St, Suite A  
Centennial, CO 80112

@LaserTechnologyInc



@LaserTechnologyInc



@LaserTechInc\_



@LaserTechPro



@Laser-Technology



**Copyright Notice:**

Information in this document is subject to change without notice and does not represent a commitment on the part of Laser Technology, Inc. No part of this manual may be reproduced in any form or by any means, electronic or mechanical, including photocopying, recording, or information storage and retrieval systems, for any purpose other than the purchaser's personal use, without the express written consent of Laser Technology, Inc.

Copyright © Laser Technology, Inc., 2024. All rights reserved.  
Printed in United States of America.

First Edition:      September 2024

**Patents:**

This product is covered by patents and pending patent applications, refer to the following website for more details: <https://lasertech.com/lti-legal/>

**Trademarks:**

MapStar, TruAngle and Measurably Superior are trademarks of Laser Technology, Inc. All other trademarks are the property of their respective owner.

**LTI Contact Information:**

Customer Support / Service:

Phone: 1.303.649.1000  
1.877.696.2584 (North America)  
Fax: 1.303.649.9710  
Email: [servicecenter@lasertech.com](mailto:servicecenter@lasertech.com)

Corporate Address:

Laser Technology, Inc.  
6912 South Quentin Street, Suite A  
Centennial, CO 80112 USA

Support, FAQ & Tech Documents:

<https://lasertech.com/software-solutions>

RMA Request:

[www.lasertech.com/customer-service](http://www.lasertech.com/customer-service)

## Table of Contents

<b>Precautions</b> .....	<b>2</b>
<b>Regulatory Certifications</b> .....	<b>2</b>
<b>Introduction</b> .....	<b>2</b>
<b>Section 1 - Introducing the LTI MapStar TruAngle II</b> .....	<b>3</b>
Unpacking the TruAngle II .....	3
Understanding How the MapStar TruAngle II Works .....	4
Tilt Sensor .....	4
Bluetooth LE (BLE) Connectivity/Communication .....	4
<b>Section 2 - Getting Started</b> .....	<b>5</b>
Parts of the MapStar TruAngle II .....	5
Layout .....	6
Powering Up .....	7
Manually Power Off .....	7
<b>Section 3 - Quick Start</b> .....	<b>8</b>
<b>Section 4 - Using the TruAngle II</b> .....	<b>9</b>
Battery Pack Installation .....	9
Battery Life Indicator .....	9
Button Layout and Functions .....	10
Friction Lock .....	10
Mounting Options .....	11
Power On .....	11
Power Off .....	11
BLE Connection .....	11
Zeroing the Unit .....	12
Entering a Non-Zero Backsight .....	12
Level Assist .....	12
LED Ring indicators: .....	12
Level Assist Visual .....	14
Taking a Measurement .....	15
Error Codes .....	15
<b>Section 5 - Care &amp; Maintenance</b> .....	<b>16</b>
<b>Section 6 - Specifications</b> .....	<b>17</b>
<b>Section 7 - LTI Limited Warranty</b> .....	<b>18</b>

## Precautions

- **Do not expose the instrument to extreme temperatures.**  
TruAngle II components are rated for Operating temperature range of -20 to 50° C (-4 to 122° F).  
Do not expose the instrument to temperatures outside these ranges.
- **Do not expose to severe mechanical shock.**  
To do so may damage the TruAngle II encoder or associated electronics.
- **Do not expose to excessive moisture or dust.**  
The TruAngle is rated IP56 - water & dust resistant. See [Page 16](#) for information about the care and maintenance of the TruAngle II.

## Regulatory Certifications

- FDA
- FCC
- CE
- IEC
- ROHS
- REACH
- WEEE

## Introduction

- The safety instructions and the user manual should be read through carefully before the product is used for the first time.
- The person responsible for the product must ensure that all users understand these directions and adhere to them.

## Section 1 - Introducing the LTI MapStar TruAngle II

The MapStar® TruAngle® II third generation of encoders that precisely calculates a turned horizontal angle that can be referenced to any desired point or direction. Integrate with any TruPulse laser to capture X, Y and Z coordinates for complete 3D mapping making it the perfect tool because it is unaffected by local magnetic interference.

### Features of the MapStar TruAngle II:

- **Bluetooth:**  
Bluetooth Low Energy (BLE), iOS & Android compatible; Laser Tech CR400 serial format.
- **Simple Intuitive User Interface:**  
3-button intuitive interface decreases field time.
- **App Driven Controls:**  
Serial commands communication.
- **Weatherproof:**  
Withstands harsh conditions with IP56 construction.
- **Rugged:**  
Holds up to everyday uses with an aluminum machined housing with rubber bumper for added protection.
- **Accuracy Confidence:**  
The Level Aid Alert used to obtain the highest degree of positional accuracy.
- **Integration:**  
Integrates with select TruPulse models to generate 3D measurements.
  - Current models: 200X, 200i, and 360i
  - Legacy models: 200, 360, and 360R
- **Ergonomics:**
  - Modular design allows you to pivot the laser rangefinder a full tilt  $\pm 90^\circ$  while maintaining the rotary encoder level.
  - Mounts easily on different set-ups, 5/8" threads:
    - Integrate in a split GPS Pole
    - Survey tripod mounting options

## Unpacking the TruAngle II

When you unpack the TruAngle II, check to make sure that you received everything that you ordered, and that it all arrived undamaged.

### Basic Package:

- MapStar TruAngle II
- Battery Pack
- Charger, AC/DC Wall mount for battery pack
- Inserts:
  - User Manual QR Code
  - Warranty Card

### Compatible Accessories:

- Laser Mounting Bracket
- Tripod

- ① • This manual is available for download from Laser Tech's Website.
- To learn more about any of the items listed above, please contact your LTI Sales Representative or an Authorized LTI Partner.

## Understanding How the MapStar TruAngle II Works

The MapStar TruAngle II is a precision instrument designed for measuring horizontal angles (azimuth) referenced to any desired point or direction. Its smooth action, facilitated by a robust, friction-lockable bearing system, ensures highly accurate azimuth data. This data can be wirelessly transferred to a central device and, when paired with a rangefinder, provides comprehensive mapping information.

The precision of the MapStar TruAngle II lies in its patent-pending, capacitively coupled rotor and resolver board set. An on-board processor conditions signals from the rotor and resolver, as well as from a separate inclinometer, providing user feedback to ensure the device remains level during measurements.

For system developers, a robust set of commands is available via Bluetooth, allowing seamless integration into custom applications.

### Tilt Sensor

The integrated tilt accelerometer sensor provides users with level indications to achieve the highest degree of positional accuracy. Using multiple light-emitting diodes (LEDs), the device accurately informs users of its level status. If the device is not level, the LEDs guide users on how to reposition it to achieve accurate leveling, eliminating the need for a liquid crystal display (LCD) or other display technology.

### Bluetooth LE (BLE) Connectivity/Communication

The TruAngle II is an App controlled device utilizing BLE only. There is no serial or USB ports for connectivity.

The TruAngle II will need a smart device with a dedicated designed App to connect, communicate and capture the angle measurements. For developers, a robust list of protocols is available over a BLE connection, refer to MapStar TruAngle II Bluetooth® Low Energy (BLE) Connectivity Protocols document on the Laser Tech website.

The Smart Device and dedicated designed App can detect the BT options and control connectivity to an LTI Laser and TruAngle II individually.

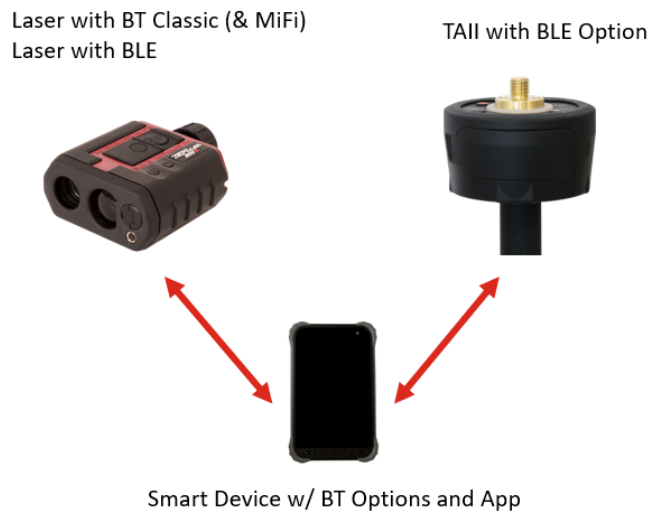

Figure 1

## Section 2 - Getting Started

### Parts of the MapStar TruAngle II

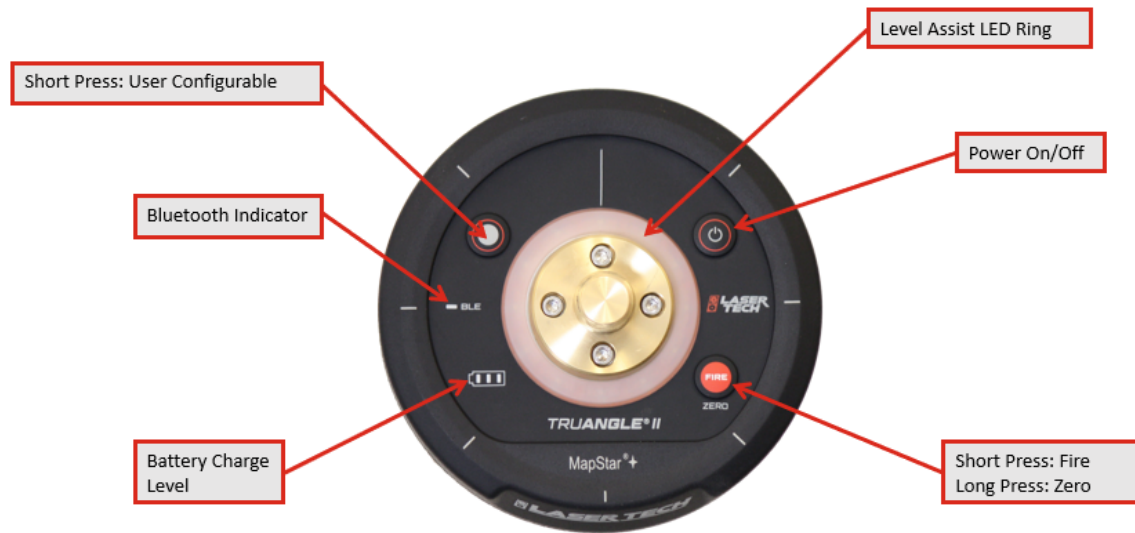

Figure 2

## Layout

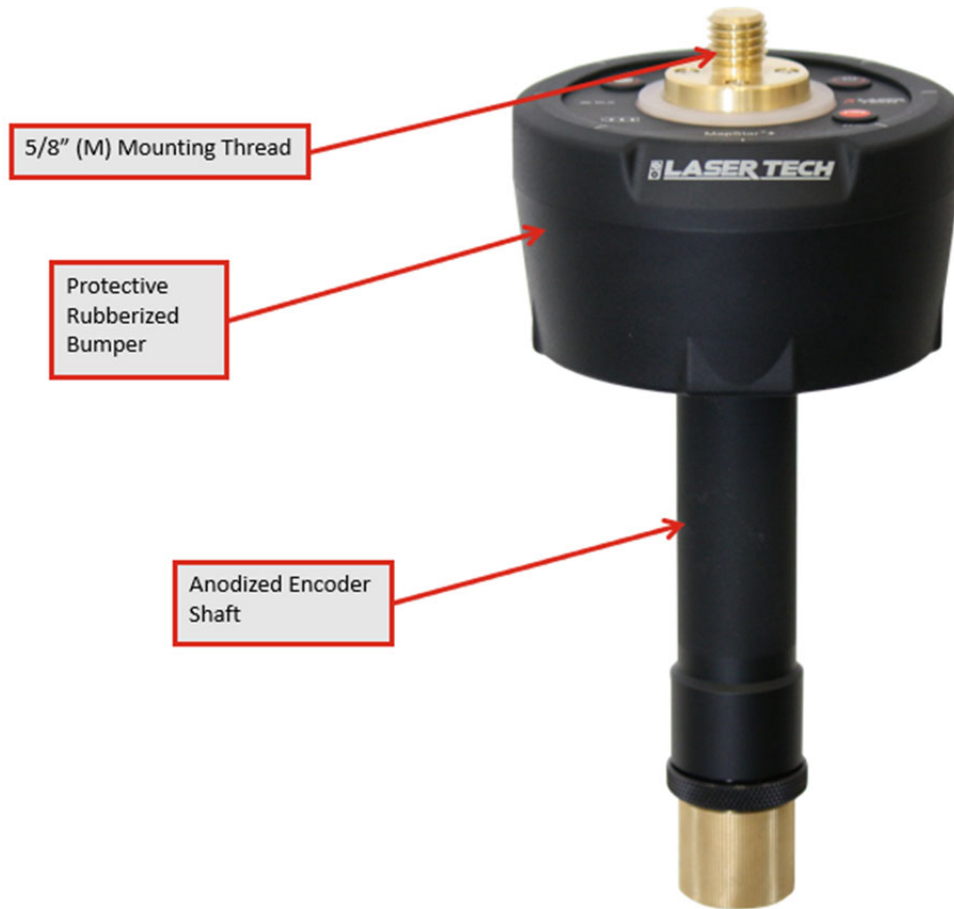

Figure 3



Figure 4



## Powering Up

Once the battery pack is installed, press On/Off button. The Level Assist, Bluetooth and Battery Charge Level indicators will light up/blink to show the unit is on and ready.

To conserve battery power, if no buttons are pressed, the unit will completely power OFF automatically after 5 minutes:

- The shut down value can be changed with serial command messages. For detailed information on the serial command messages, refer to the Laser Tech's Professional Measurement FAQs technical documents website (<https://lasertech.com/professional-measurement-faqs/>).

## Manually Power Off

The TruAngle II can be powered off by pressing and holding the On/Off button for 3 seconds.

### Section 3 - Quick Start

1. Install charged battery pack (Page 9).
2. Mount to selected mounting options.
3. Press the On/Off button to power on the unit.
4. Connect to smart device via App Bluetooth communication.
5. Zero the unit by long pressing the Fire/Zero button.  
All the Level Assist LEDs will flash 3 times indicating the unit has been zero referenced.
6. Ready to measure horizontal angles.
7. To power off, long press the On/Off button for 3 seconds.



Figure 5

## Section 4 - Using the TruAngle II

### Battery Pack Installation

The TruAngle II is powered by lithium-ion battery pack.





1. Open the battery compartment cover by gently pulling the battery pack door.
2. Install the battery pack and slide the battery lock to install.
3. Replace the battery pack door.



Figure 6

### Battery Life Indicator

The TruAngle II monitors incoming battery voltage, and its Battery Life Indicator displays the remaining battery charge.

-  Full
-  2/3
-  1/3
-  Battery Lock Out Screen

## Button Layout and Functions

The TruAngle II has three buttons. Looking at the faceplate of the TruAngle II:



Figure 7

### A Configuration Button

- Short press: App user configurable
- Long Press: Initiate IMU calibration routine

### B On/Off Button

- Short press: Turns on the unit
- Long Press (3 seconds): Turns off the unit

### C Fire and Zero Button

- Short press will fire the unit to output the current horizontal angle
- Short press to accept orientation and reference the TruAngle II at the value displayed.
- Long press activates the Zero mode

## Friction Lock

Tightening the Friction Lock keeps the encoder from rotating by adding friction to the base of the encoder shaft.

- Adjust as needed.
  - Rotate the Friction lock counterclockwise to add friction to keep the encoder from rotating freely.
- NOTE** Do not over tighten the Friction lock, can be damaged.

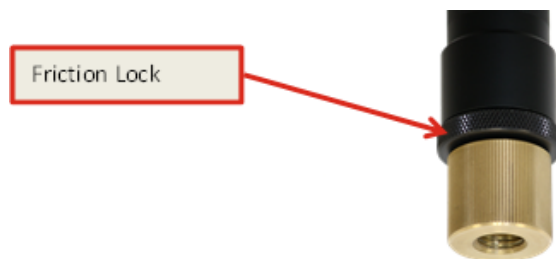

Figure 8

## Mounting Options

The TruAngle II has 5/8" threads (Top Male; Bottom Female) to mount to different type of mounting accessories.

- 2m Two-piece GPS rover rod/pole
- Survey tripod with Tribach and adapter

TruAngle II dimension height might be necessary with field apps that need an GPS/GNSS total antenna height.

- Height 225.0 mm (8.86 in)



Figure 9

## Power On

To power on the unit, press the On/Off button. The following LEDs will illuminate indicating the unit is on:

- Battery LEDs will be illuminated indicating battery status (Page 9).
- Bluetooth LED will be illuminated and blinking.
- Level Assist LEDs: 4 LEDs will blink indicating level within Level Visual value.

## Power Off

To Power off the unit, long press (3 seconds) the On/Off button.

- To help save the battery life, the unit has a factory defined power off setting. The unit will automatically power off if there is no activity for a period after 5 minutes. Instrument activity includes button presses, measurements, angle rotation measurements, tilt level changes, or App commands.
- Any activity will reset the auto power off timer.
- The unit can power off even if Bluetooth connected to an App and if there is non-activity.
- The default time is changeable by user via BLE Protocol serial command
  - Timeout Interval Set (To set value for #TO) #TO,nnn
  - Default is 5 minutes

## BLE Connection

The TruAngle II Bluetooth model is a Bluetooth Low Energy (BLE) that is designed to create low data rate networks using a minimum amount of power.

- BLE module is compatible with a multitude of data collection mobile devices (iOS and Android operating systems).
- BLE Advertisement Name: The name that mobile devices will see when "scanning" for a Bluetooth device.
  - TAIL-000100 (Product Name Abbreviated and Serial Number of the unit)

Refer to the instructions below when connecting your TruAngle II to a mobile device. This information is provided as a general guideline.

1. Power on the TruAngle II unit and verify the blue BLE LED is flashing.
2. Power on the mobile device and turn on Bluetooth in the settings menu.
3. Start the dedicated designed App and Scan for the TruAngle II.
4. Select the TruAngle II and the BLE LED will become solid.

Bluetooth troubleshooting tips:

- TruAngle II: Verify that the TruAngle II Bluetooth is ready to connect.
- Bluetooth enabled PC device: Verify that the Bluetooth connection is active.
- Verify that the Bluetooth device is physically located within the wireless transmission range of the TruAngle II.
- Do not Pair the TruAngle II to the mobile device in the Bluetooth Settings menu. Pairing is only used for Bluetooth Classic connectivity.
- **NOTES**
  - Refer to the third party product documentation for your specific Bluetooth device.
  - Refer to the third party App documentation for specific connection instructions.

## Zeroing the Unit

The TruAngle II does not need to be indexed or calibrated to zero the unit.

1. Long Press the Fire/Zero button.
2. Invokes the zero-degree quick reference feature that sets the horizontal angle equal to zero degrees (0.00°) and references all turned angles to that user-defined heading.
3. All Level Aid LED lights will illuminate and blink 3 times, Indicating the unit has been "zero'd".
4. All new measurements will be referenced from the zero angle set.

## Entering a Non-Zero Backsight

Setting a Backsight (new reference horizontal angle) is the process of pairing a reference angle, or Backsight angle, with a selected direction.

## Level Assist

The Level Assist is available to help keep the TruAngle II upright to obtain the highest degree of positional accuracy for horizontal angle measurements.

- Know when unit is tilted from plumb or out of tolerance.
- Past the Level Assist Visual Limit & Error Limit value set
- Alerts user when outside tilt factory or user-defined limit.
- If out of Level Assist Error Limit value defined settings, the horizontal angle is not measured.

LED Ring indicators:

- Level aid indicator for the 4 quadrants; electronic bubble level; Red LEDs = 12
- Level Aid Assist LEDs is a bubble level in the way they light up and which direction to re-level ([Page 14](#)).



In the above example, the 4 LEDs at 12, 3, 6 and 9 o'clock are lit to show the unit is in level.

Figure 10

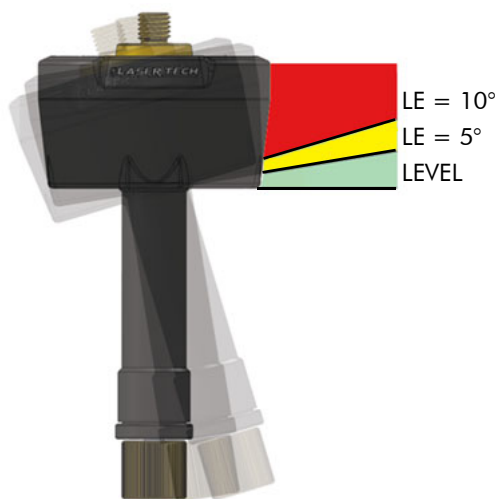

**LV and LE settings and limits:**

- **LV** = Level Assist Visual Limit Set
  - Sets when the visual LEDs begin to indicate plumb angle.
  - Minimum value = 4
  - Maximum value = 440
  
- **LE** = Level Assist Error Limit Set
  - Sets the value to send an #ER,3 warning limit
  - Minimum value = 14
  - Maximum value = 450
  
- LE - LV must always be > 1 degree



LV = Level Assist *Visual* Limit (Default = 2°)  
 LE = Level Assist *Error* Limit (Default = 6°)

Figure 11

ZONE	TILT ANGLE	RESPONSE
	Above LE value (10°)	Level Assist LEDs all on solid, responds with error message (#ER,3) when first crossed and when queried
	Between LV value (5°) and LE value (10° in this case)	Bubble level aid to re-level, responds with angle when queried
	Between perfectly level (0°) and LV value (5° in this case)	4 LEDS Flashing, responds with angle when queried (#AN)

**NOTE** It's best that the LV and LE values have a reasonable separation between them to be most useful. If the set values are too close to each other, the bubble level aid becomes too sensitive.

Examples:

- LV = 2°, LE = 6°, Span = 4° (DEFAULT)
- LV = 2°, LE = 10°, Span = 8°

## Level Assist Visual

If the unit is off level - in the example shown, a max of 7 LEDs will show extreme off level. This represents the bubble meaning the unit needs to be tilted in the direction of the lit LEDs to begin leveling the unit. As this is achieved, the number of lit LEDs decrease until 1 is left lit.

- When the unit is fully level, all LEDs will light up briefly to indicate that it is level and then the 4 LEDs at 12, 3, 6 and 9 o'clock will be lit to show the unit is in level.
- If the unit is moved out of level repeat the reverse of the above starting from 1 LED up to 7.
- If the unit is rotated, it continues to simulate a bubble by moving the group of LEDs around the ring.
- **NOTE** In Figures 12, 13, and 14 each red dot represents a lit LED. The black dots are not visible, and are only for reference. These LEDs would be off/not illuminated.

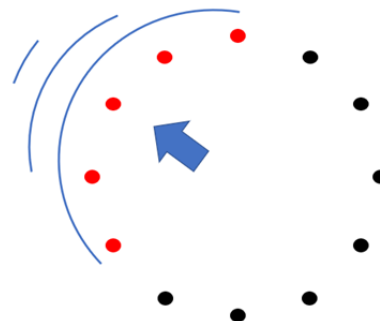

Figure 12

When the Level Assist Visual is active, it represents a visual bubble level.

To level the unit, tilt the unit "towards" the illuminated LEDs. Once level, the 4 LEDs will blink.

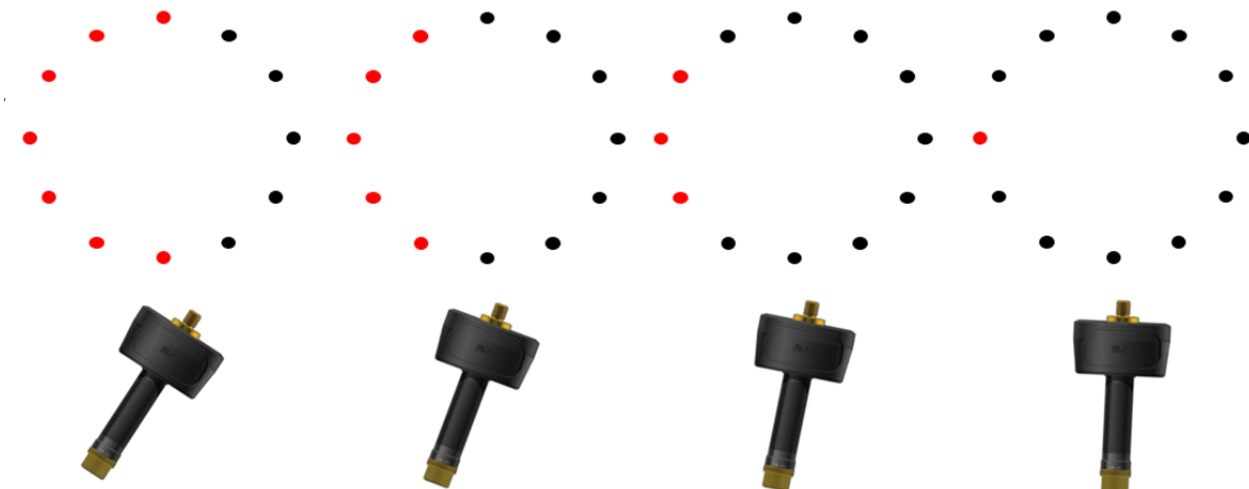

Figure 13

The Level Assist will always blink 4 LEDs until the Level Assist Visual Limit is exceeded. If LV is set to 40°, the 4 LEDs will blink indicating unit is level and not past the LV limit value, even though the unit is tilted 40°.

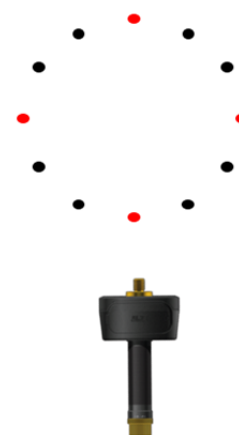

Figure 14



## Taking a Measurement

To measure an angle after zeroing the unit to setting a non-zero backsight:

### Manually:

1. Rotate the unit until it is pointing in the desired direction.
2. Press the Fire button to record the current angle.
3. The angle will download the angle measurement to an App.
4. The TruAngle II is ready for a new angle measurement.

### Electronically using an App:

1. Rotate the unit until it is pointing in the desired direction.
2. Press the Fire button to record the current angle.  
\*or\*  
Use the App to fire/measure to record the current angle.
3. The angle will download the angle measurement to an App.
4. The TruAngle II is ready for a new angle measurement.

## Error Codes

The error code listed below will be viewed in an App.

Error Code: #ER,n

- 1 = Command Syntax Error
- 2 = Memory Checksum Error
- 3 = Level Assist Tilt Warning

## Section 5 - Care & Maintenance

The batteries are the only user-replaceable parts in the TruAngle II. Do not remove any screws. To do so will affect or void the LTI Limited Warranty.

- **Temperature Range**

TruAngle II components are rated for Operating temperature range of -20 to 60° C (-4 to 140° F). Do not expose the instrument to temperatures outside these ranges.

- **Protecting from Moisture and Dust**

The TruAngle II is sealed to provide protection from normally expected field conditions. It is protected from dust and rain, but will not withstand submersion.

If water leakage is suspected:

- Power OFF the TruAngle II.
- Remove the battery pack.
- Air dry the TruAngle II at room temperature with the battery compartment open.

- **Protecting from Shock**

The TruAngle II is a precision instrument and should be handled with care. It will withstand a reasonable drop shock. If the unit suffers from a severe drop shock, you may need to send the unit to LTI for service repair.

- **Transporting**

When transporting the TruAngle II, the unit should be secured in the provided carrying case. The provided neck strap can be used when carrying the TruAngle II in the field.

- **Cleaning**

Clean the TruAngle II after each use, before returning to the carrying case. Check all of the following items:

- Excess moisture. Towel off excess moisture, and air dry the instrument at room temperature with the battery pack removed and the battery compartment open.
- Exterior dirt. Wipe exterior surfaces clean to prevent grit buildup in the carrying case. Isopropanol may be used to remove dirt and fingerprints from the exterior.
- Transmit and Receive Lenses. Use the provided lens cloth to wipe the lenses. Failure to keep the lenses clean may damage them.

- **Storing**

If you won't be using the TruAngle II again soon, remove the battery pack before storing the instrument.

## Section 6 - Specifications

All specifications are subject to change without notice. Please refer to LTI's website for current specifications. If you are not able to locate the information on the website or if you do not have internet access, please contact LTI via phone or fax.

Horizontal Angle	Accuracy $\pm 0.1^\circ$
Horizontal Angle Range	0° to 359.99°
Horizontal Angle Resolution	0.01°
Tilt Accuracy	Maintains +/- 0.1° accuracy at up to +/-10° tilt* * Nominal Calibration Angle Tolerance is 95% level of confidence under normal test conditions at a temperature of 23° C and Barometric Pressure of 101kPa
Wireless Communication	Bluetooth Low Energy (LE): Android & iOS compatible.
Temperature Range:	-20 to +50° C (-4 to +122° F)
Battery Pack	Li-ion Rechargeable, Replaceable/Removable; 12hrs Continuous Use
Environmental	Weatherproof IP56 rating
Mount	5/8" threads: Top Male, Bottom Female
Leveling	Level Aid utilizing Ultra bright LEDs (bubble level) to indicate when the unit is level or over the level limit.
Size	Total Height: 240.3 mm (9.46 in)
Mounted Height:	225.0 mm (8.86 in)
Width / Diameter:	114.3 mm (4.5)
Weight	1,270 g (2.8 lbs)

## Section 7 - LTI Limited Warranty

### What is Covered?

Laser Technology, Inc. (LTI) warrants this product to be in good working order. Should the product fail to be in good working order at any time during the warranty period, LTI will, at its option, repair or replace this product at no additional charge.

Parts and products that have been replaced as a result of a warranty claim become the property of LTI.

### What is the Period of Coverage?

This warranty remains in force for two years from the date of purchase from LTI or an authorized LTI product dealer; unless otherwise noted by LTI at the time of sale. LTI reserves the right to require written verification of the date of the original purchase of any product.

### What is Not Covered?

LTI has no obligation to modify or upgrade any product once sold. Any reproduction of software products is strictly forbidden. This limited warranty does not include service to repair damage to the product resulting from:

- Accident
- Disaster
- Misuse
- Abuse
- Non-LTI modification
- Batteries or damage caused by batteries used in our products.

In no event will LTI be liable to you for any damages, including any lost profits, lost savings, or other incidental or consequential damages arising out of the use or inability to use such product. Furthermore, LTI shall not be held responsible if an LTI authorized dealer has been advised of the possibility of such damage, or for any claim by any other party.

### What Will We Do to Correct Problems?

If this product is not in good working order as warranted above, your sole remedy shall be repair or replacement as provided above.

### How does State Law Relate to this Warranty?

LTI hereby disclaims all other express and implied warranties for the product, including the warranties of merchantability and fitness for a particular purpose. Some states do not allow the exclusion of implied warranties, so the above limitations may not apply to you.

### How do You Get Service?

In the unlikely event that your LTI product should require warranty or repair service, contact us to receive a Return Merchandise Authorization (RMA) number before returning your product.

If the product is delivered by mail, you agree to insure the product or assume the risk of loss or damage in transit. In addition, the shipping container or equivalent, will be sent prepaid and for door-to-door delivery.

### Why Should You Complete and Return the Warranty Validation Card to LTI?

The Warranty Validation Card (shipped in the box with your TruAngle II) must be completed and received by LTI in order to benefit from this limited warranty. If an LTI software product requires registration, this must also be completed to benefit from this limited warranty. Receipt of the warranty validation card not only activates the limited warranty, it also allows LTI to contact you directly when hardware or software upgrades become available.

If you prefer to register your LTI product electronically, please visit our website ([www.lasertech.com/Warranty-Registration.aspx](http://www.lasertech.com/Warranty-Registration.aspx))